

THULE[®]
SWEDEN

- S** Monteringsanvisning
- GB** Fitting instructions
- D** Montageanleitung
- F** Instructions de montage
- NL** Montage-instructies
- FIN** Asennusohje
- E** Instrucciones de montaje
- I** Istruzioni per il montaggio
- CZ** Návod na montáž
- PL** Instrukcja montażu
- HU** Szerelési utasítások
- RU** Инструкции по установке
- EST** Paigalduseeskirjad
- SLO** Navodila za pritrjevanje

한국어 장착 지침

日本語 取扱(取付)説明書

中文 安装说明

RAPID SYSTEM

755 755-1

1254-1

1244-1



Follow me...

THULE
SECURID

S: Suojavälikkeiden
 GB: Security appliances
 D: Sicherheits-Vorrichtungen
 F: dispositifs de protection
 NL: veiligheidsvoorzieningen
 FIN: Turvallisuusvälikkeet
 F: Appareils de sécurité
 CE: Húvudökumun
 PL: Urządzenia bezpieczeństwa
 PT: Aparelhos de segurança
 GB: Sicherheits-Vorrichtungen
 FR: Appareils de sécurité
 SV: Särskilda säkerhets
 RU: Средства по безопасности
 SK: Prístroje bezpečnosti
 EST: Ohutusvahendid
 LT: Saugumo įrenginiai
 LAT: Drošības ierīcības
 SLO: Varnostni pripomočki
 HUN: Biztonsági eszközök
 FIN: Suojavälikkeet

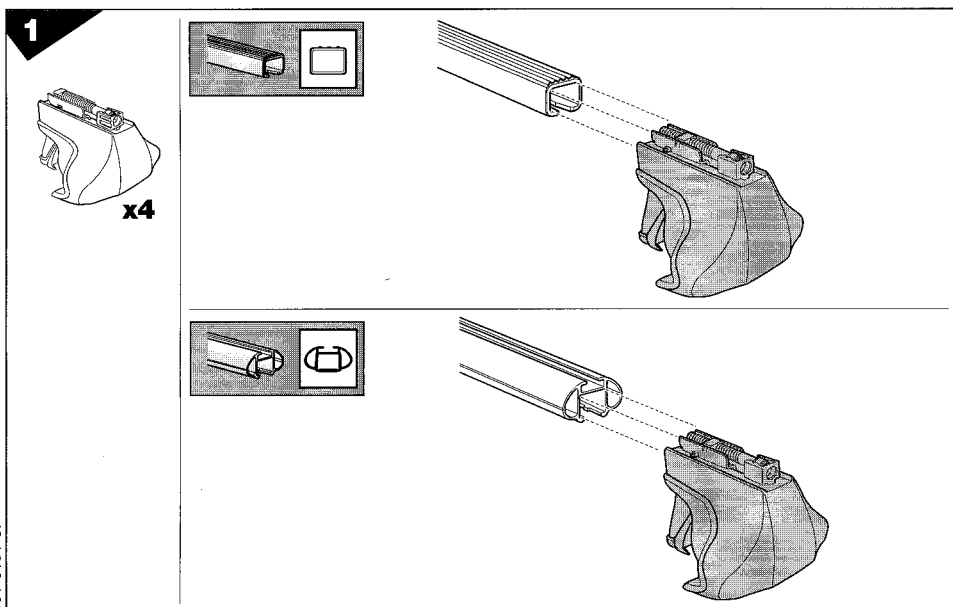
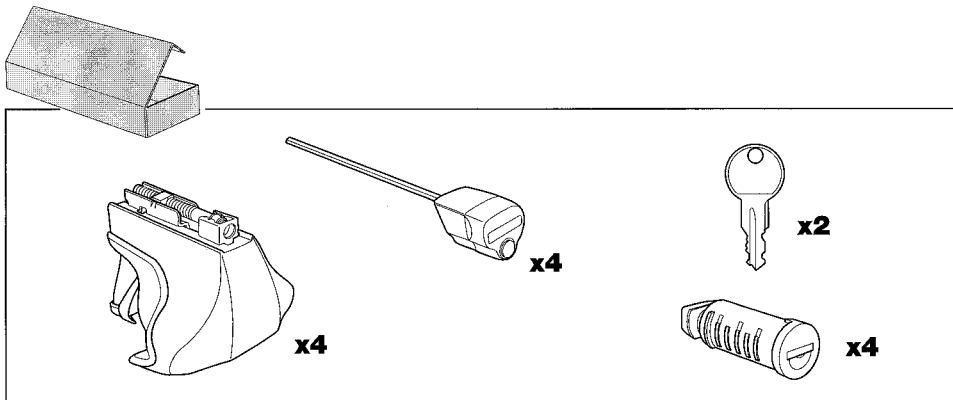
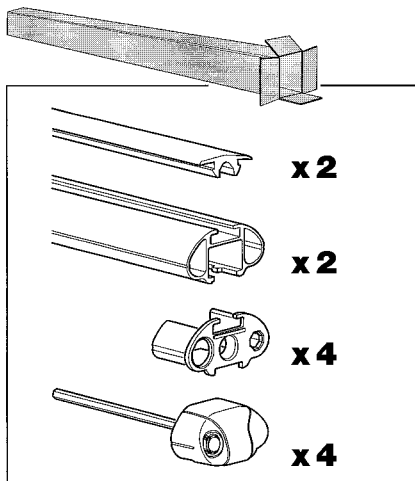
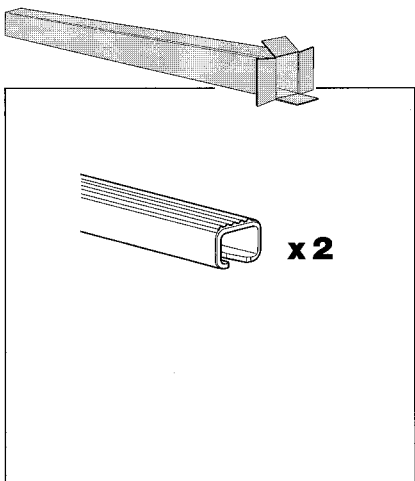
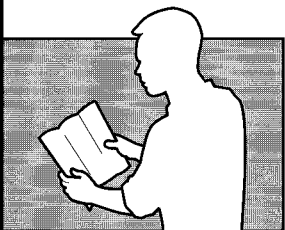
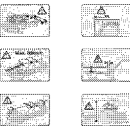

2

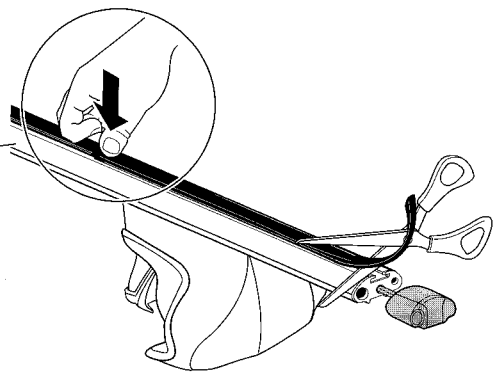
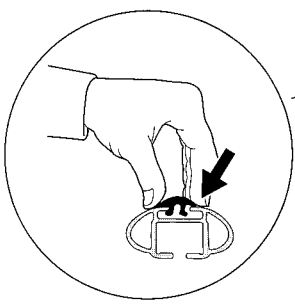
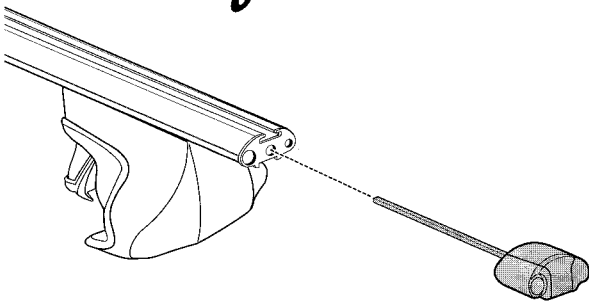
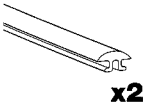
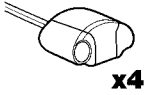
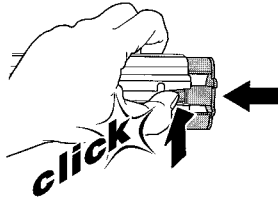
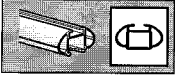
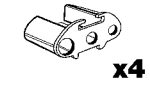
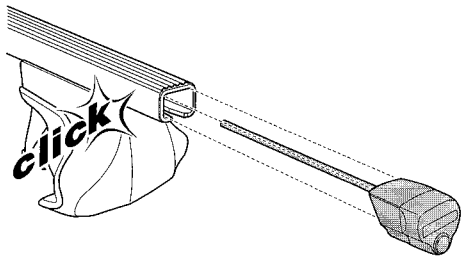
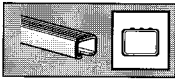
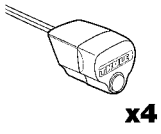

3

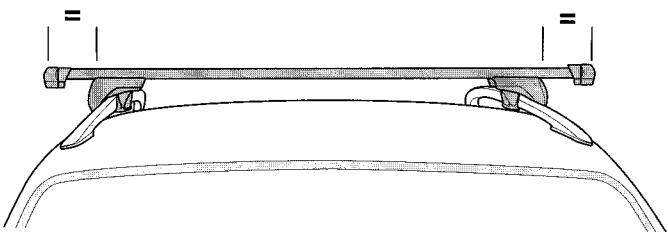
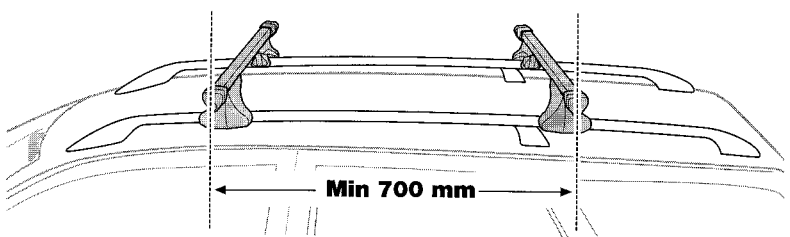
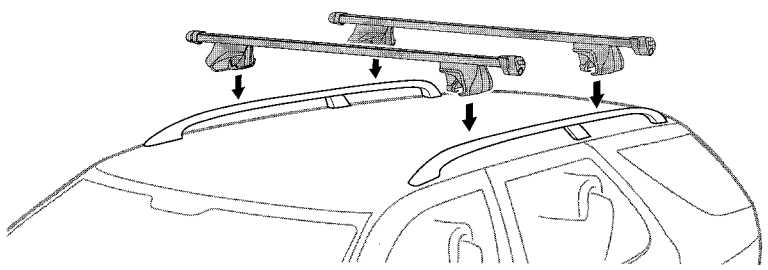

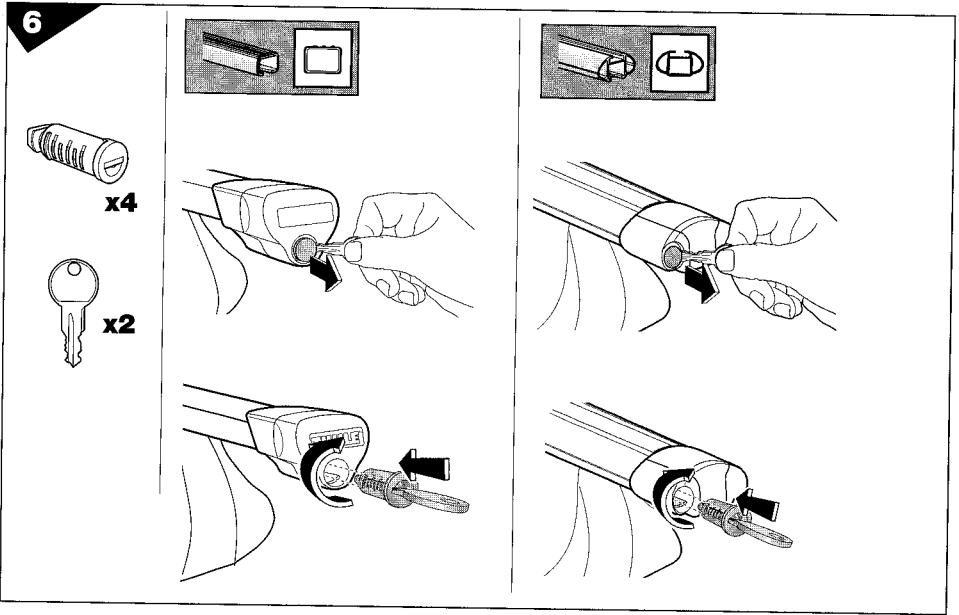
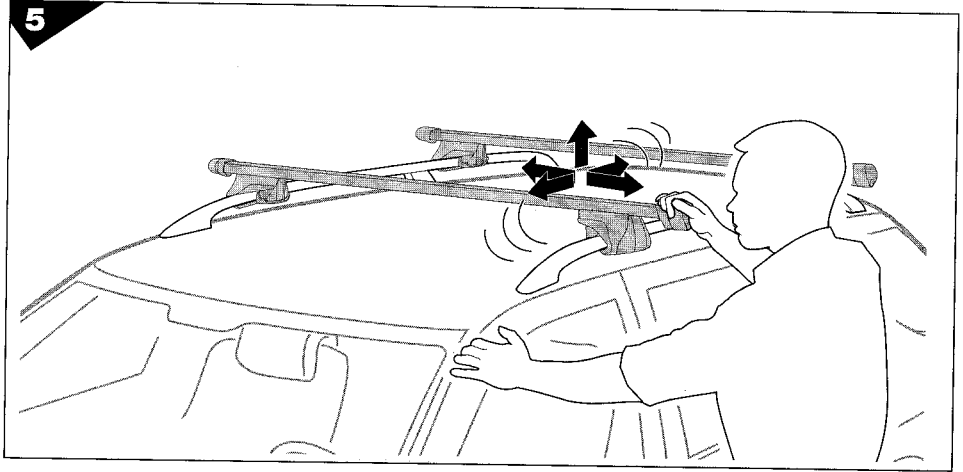
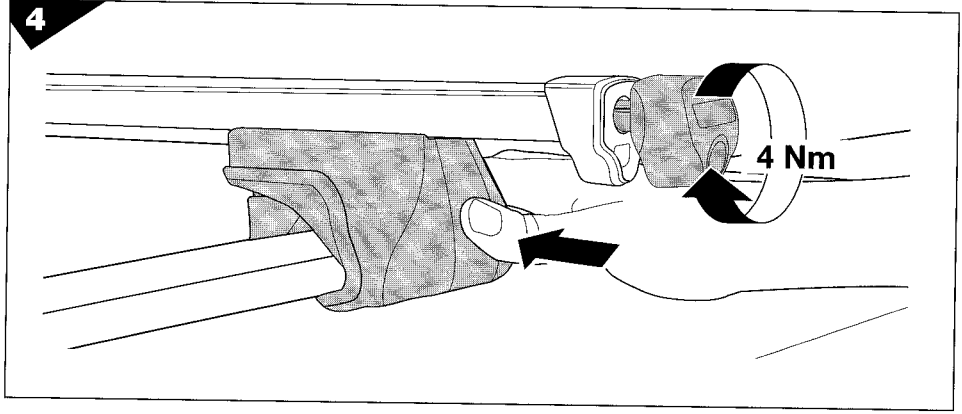

S Demontering
GB Removal
D Demontieren
F Démontage
NL Demontage
FIN Irrotus

E Desmontaje
I Rimozione
CZ Odmontování
PL Wymontowywanie
HU Leszerelés
RU Снятие

EST Eemaldamine
SLO Odstranjevanje
 한국어 분리
 日本語 取り外し
 中文 拆除

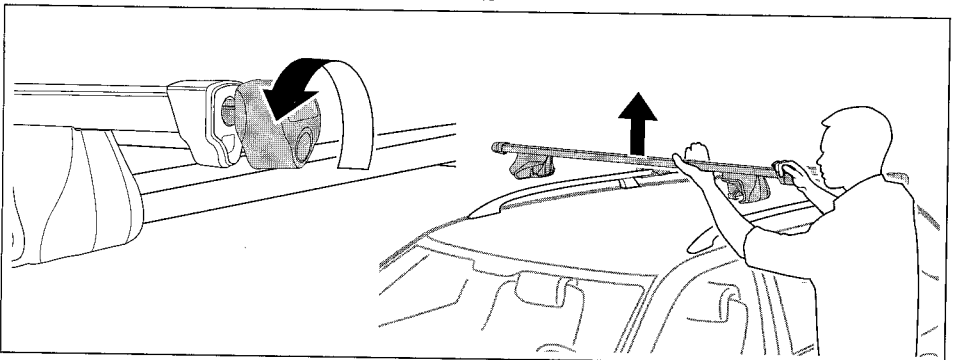

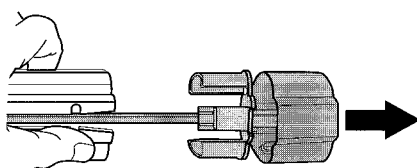
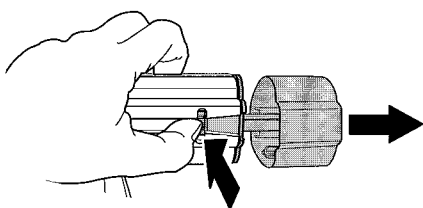
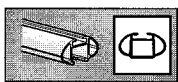
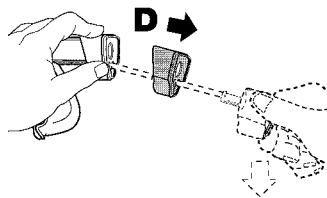
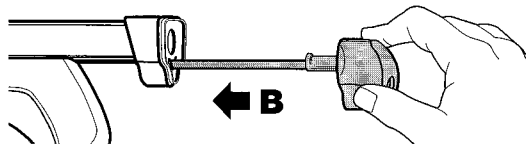
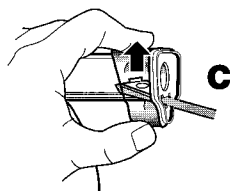
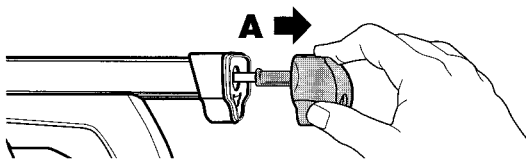
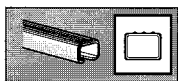

Min 700 mm

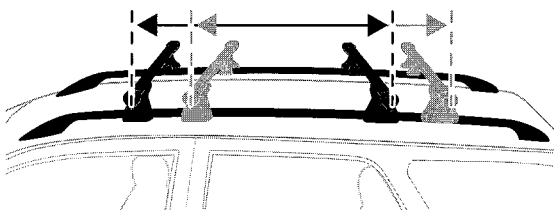

S Eventuellt vindbrus kan minska om lasthållaren flyttas något. Min avståndet skall inte ändras.

GB If there is any wind rush noise, this can be reduced if the load carrier is moved slightly. The minimum distance, however, should not be altered.

D Durch Versetzen der Lastenträger lassen sich etwaige Windgeräusche verringern. Der Mindestabstand muss jedoch eingehalten werden!

F Le bruit éventuel du vent peut être réduit en déplaçant légèrement les barres de toit. La distance minimum entre elles ne doit cependant pas être modifiée.

FIN Mahdollista tuulen aiheuttamaa huminaa voi vähentää siirtämällä taakkatelinettä hieman. Vähimmäisetäisyyttä ei saa muuttaa.

E Si se produce ruido por el viento, puede reducirse si el portaequipajes se cambia de sitio desplazándolo un poco. La distancia mínima no deberá modificarse.

I L'eventuale brusio del vento può essere ridotto spostando leggermente il portapacchi. In ogni caso, non modificare la distanza minima.

NL Mogelijk kan het windgeruis worden gereduceerd door de imperiaal een stukje te verplaatsen. De minimumafstand dient te niet worden gewijzigd.

CZ Pokud zaznamenáte nadměrný hluk vzduchu, mírným posunutím nosiče jej můžete snížit. Minimální rozteč ale nesmí být překročena.

PL Nadmierny hałas powstający podczas jazdy można zredukować zmieniając nieco położenie belek. Należy jednak zachować minimalny zalecany rozstaw.

HU Az esetleges szélzaj a tehertartók csekély elmozdításával csökkenthető. A minimális távolságot azonban nem szabad módosítani.

RU Если возникает сильный шум ветра, его можно уменьшить, слегка передвинув багажник. Однако минимальное расстояние нельзя изменять.

EST Kui sõidu ajal tekib liiga tugev tuulemüra, võib see väheneda, kui jalgrattahoidikut veidi nihutada. Minimaalset vahekaugust ei tohi siiski muuta.

SLO Hrup zaradi vetra lahko zmanjšate s rahlim premikom prtljajnika. Pri tem pa ne spreminjajte minimalne razdalje.

한국어 바람 소리가 심하게 들리는 경우 캐리어를 약간 움직이면 소리가 줄어들 수 있습니다. 하지만 최소 간격은 유지되어야 합니다.

日本語 突風音がする場合は、積荷キャリアをすこしずらすと音を小さくすることができます。ただし、最小距離は変更しないでください。

中文 如果有风噪,则在货物托架发生轻微移动的情况下,可以调小一些。但是,不应改变最小距离。

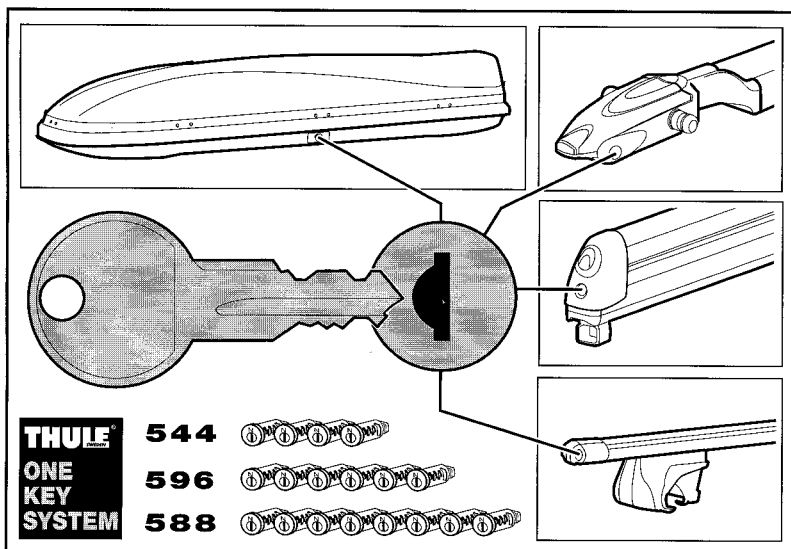
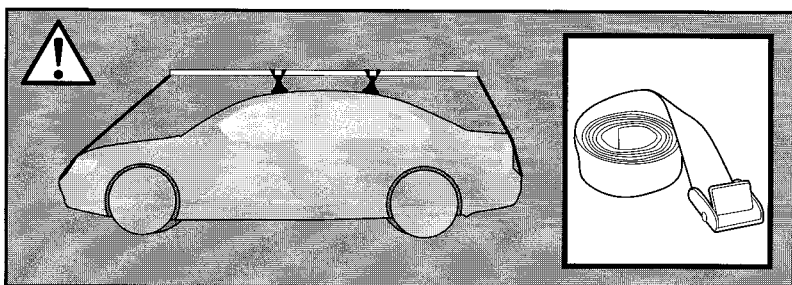
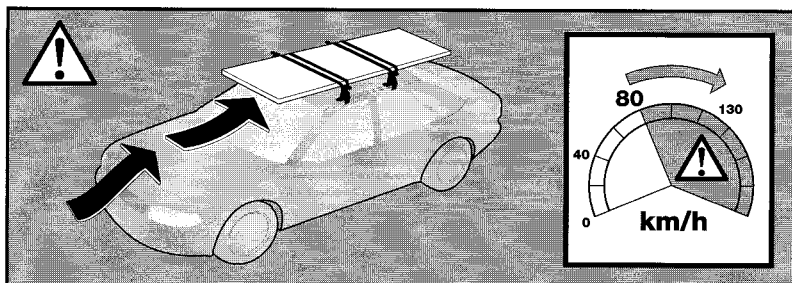
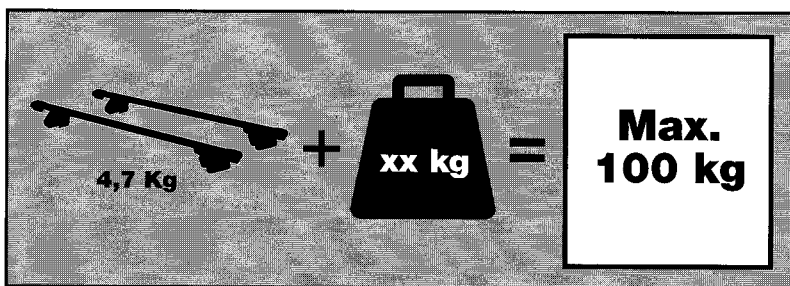

Se não houver instruções no seu idioma, entre em contato com os funcionários do estabelecimento para obter informações

Eğer talimatlar dilinizde basılı değilse, lütfen atölye personelinden bilgi isteyiniz.

Αν οι οδηγίες δεν εκτυπώνονται στη γλώσσα σας, παρακαλούμε ζητήστε πληροφορίες από το προσωπικό του καταστήματος.

ถ้าไม่มีคำแนะนำในภาษาของคุณ โปรดติดต่อพนักงานในร้านเพื่อขอข้อมูล

THULE[®]
SWEDEN

Box 69, 330 33 Hillerstorp, SWEDEN
www.thule.com